

## Pins

Pins for drop forged chains are available in material:

16MnCr5, 42CrMo4i, 1.4034i, 1.4122i, 1.4462, 1.4713. Other materials on request.



circlip

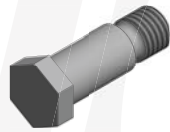

hex pin with thread



head pin with circlip



head pin with collar and dowel pin

## Example of scrapers

Bechtel can supply all kinds of scrapers. Whether it is horizontal, inclined or vertical transport, there is a special version for every type of transport and a solution for every capacity. Below you will find a number of examples of steel scrapers and plastic flights.

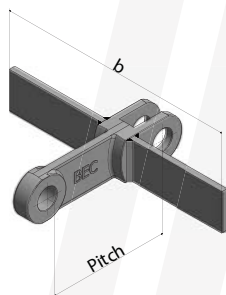

Horizontal transport

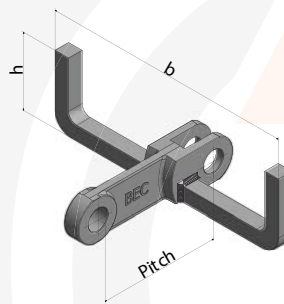

"U" scraper for inclined transport

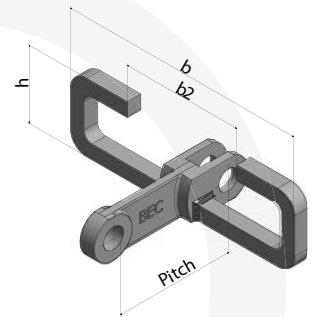

"O" scraper for vertical transport

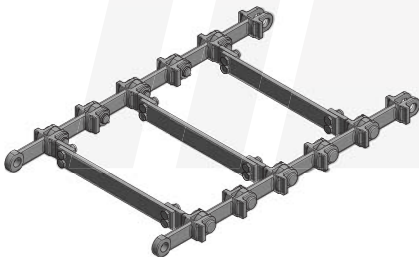

Double drop forged chain scraper

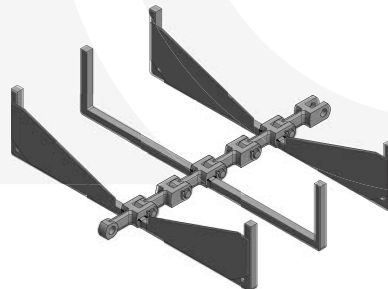

"U" scraper with welded plates

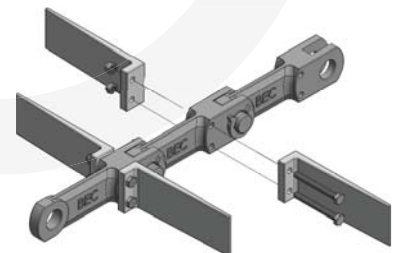

Easy to (dis)assemble plastic flights